

HYUNDAI
POWER PRODUCTS

CONCRETE MIXER

HBTE125L/HBTE145L/HBTE180L

ORIGINAL INSTRUCTIONS

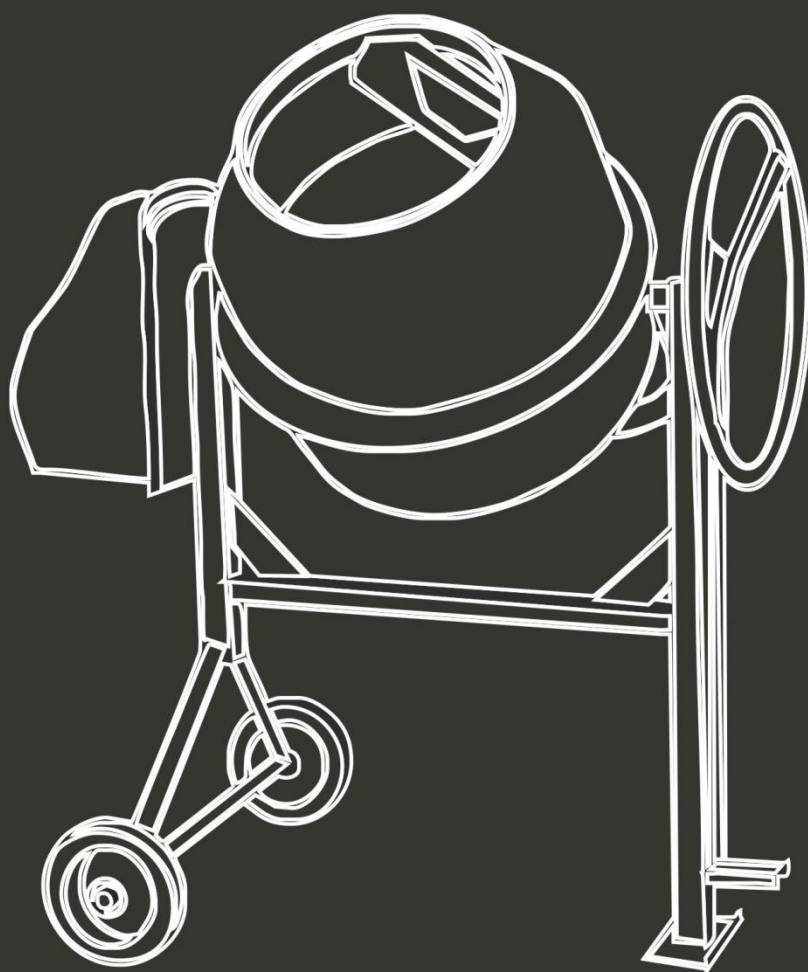

WARNING: Read thoroughly the instruction manual before use.

CONTENT

1. INTENDED USE.....	3
2. RESIDUAL RISKS.....	3
3. SAFETY INSTRUCTIONS.....	3
4. ELECTRICAL SAFETY.....	5
5. SYMBOLS.....	7
6. PRODUCT DESCRIPTION.....	9
7. TECHNICAL DATA.....	9
8. ASSEMBLY INSTRUCTIONS.....	10
9. OPERATION INSTRUCTIONS.....	15
10. MAINTENANCE INSTRUCTIONS.....	17
11. DISPOSAL.....	17
12. DECLARATION OF CONFORMITY.....	18
13. WARRANTY.....	19
14. PRODUCT FAILURE.....	20
15. WARRANTY EXCLUSIONS.....	21



Read and understand the operating instructions before using the appliance. Familiarize with the control elements and how to use the appliance properly. Abide by all the safety measures stated in the service manual. In case of any doubts about connection and operation refer please to our customer center: <https://services.swap-europe.com/>

1. INTENDED USE

The concrete mixer has been designed to be used exclusively for concrete and mortar production. Do not use this product in any other way as stated for normal use. Not observing general regulations in force and instructions from this manual does not make the manufacturer liable for damages.

2. RESIDUAL RISKS

There can still be some residual risks given by the machine design despite using the machine in accordance with all the respective safety regulations. Residual risks may be minimized by following the safety instructions and use as designated provisions and the Operating Instructions. Caution reduces the risk of personal injury and material damage.



DANGER OF INJURY!

Risk of injury of fingers and hands when touching the running mixer drum by hand. Protection against dangerous getting caught or wound by the rotary spreader cannot be provided.



WARNING! Electric shock! There is a risk of an injury caused by electric shock!

Risk by current when using inappropriate connecting cables

Do not touch supply conductors of exposed electrical components. There can still be some hidden risks despite all the preventive measures taken.

3. SAFETY INSTRUCTIONS

Please follow these instructions to protect yourself and other persons against potential risks and injuries.

1. Use protective equipment. Always wear safety glasses when working with the machine. The use of protective clothing is recommended, such as dust mask, protective gloves, eyes protection and sturdy non-slip footwear and ear defenders.
2. Do not touch, inhale (dust development) or consume the cement and additives.
3. Comply with the local injury prevention regulations and safety regulations in the work area.
4. Adequate light conditions must be provided.
5. The concrete mixer can only be used after complete installation of all parts.
6. Install and operate the concrete mixer on a solid and flat surface (making

- sure it does not fall over).
7. To prevent tripping, remove any obstacles on the site.
 8. The operator is responsible to third persons in the work area.
 9. Do not operate the mixer unattended.
 10. Do not let children near the mixer.
 11. Mixer to be only used for works given in paragraph "Use as designated".
 12. Do not modify the machine or any of its parts.
 13. The mixer can only be put into operation with complete and intact safety equipment.
 14. Check the moving parts for perfect functioning, if working smoothly and if no parts are damaged. To provide safe operation of the equipment, all parts must be installed properly and meet all conditions.
 15. Damaged protective equipment and parts must be professionally repaired or replaced by a recognized professional workshop, unless otherwise specified in the Operating Instructions.
 16. Defective or damaged parts of the machine to be immediately replaced. Any damaged or illegible safety stickers must be replaced.
 17. Original spare parts to be used only. Using other spare parts can result in accidents/injuries of the user. The manufacturer will not be liable for any such damage.
 18. Check regularly this machine. Check all bolts, nuts, and screws for tightness before each use, especially those securing guards and drive mechanisms. Vibration during mixing may cause these to loosen.
 19. Form a habit of checking to see that all the adjusting tools, shovels, hand towels and other tools/equipment are removed from mixer area before turning it on.
 20. Replace damaged, missing or failed parts before using it. Warning labels carry important information. Replace any missing or damaged warning labels.
 21. The tool shall be supervised when switched off and put out of children and animals, in order to avoid risks.
 22. The machinery shall not be operating when it is being moved.
 23. The mixer shall be positioned on level ground.
 24. Do not reach into the drum interior to the rotating blades.
 25. Warning - use only the original standard of insulation material for repair and to maintain insulation distances.
 26. Disconnect the mixer from power supply before opening the enclosure and do not operate it unless the enclosure is fully closed.

4.ELECTRICAL SAFETY



Operation is only allowed with a safety switch against stray current (RCD max. current of 30mA).

WARNING! Before opening the housing, disconnect from the electric grid. The housing must be fully closed before operating the machine.

1. Concrete mixer with protective insulation, (Protection class II)
2. The machine can only be put into operation when the cladding is complete and firmly enclosed.
3. Before using the connecting cables, check them for defects or aging. Never use defective connecting cables.
4. Connecting cables not to be used for purposes for which they are not designed. Protect the cable against heat, oil and sharp edges. Do not use the connecting cable to pull the plug out of the socket.
5. Long and thin connecting cables cause a drop in voltage. The engine is no longer reaching its maximum power and the equipment function is reducing.
6. Cable must be unwound to the full extent when a cable drum is used.
7. When extending the connecting cable make sure it does not get jammed, broken and the plug is not wet.
8. Connecting cables with a rubber socket with a plug for more difficult conditions, protected against spraying water, to be used.
9. Do not use any provisional electric appliances. Never remove or switch off the protective equipment and never put it out of operation.
10. Design of the connecting cables according to IEC 60245-4 1980 (DIN 57 282) with H 07 RN-F marking or equivalent types of design. Core cross section of at least 3 x 1.5 mm² for a maximum length of 25 m.
11. Electrical connection and repairs on the electrical line must be provided by a licensed electrical professional and local regulation, the protective measures, in particular, must be complied with.
12. Repairs on electrical parts must be executed by the producer or companies specified by the producer.
13. If the supply cord is damaged, it must be replaced by a special cord or assembly available from the manufacturer or its service agent.

WARNING! The protection class II will only be maintained when original

insulation materials/components are used for a repair and when the insulation distances are not changed.

OPERATION

1. Never touch inside the running mixer drum (rotary stirrer). Keep adequate safety distance from the mixer.
2. Prevent any contact with the rotary or moving parts of the machine.
3. The mixer drum is to be only filled and emptied when the engine is running.
4. Pay attention to the mixer drum rotation direction.
5. Do not change the engine revolutions as they regulate the maximum safe work speed possible and protect the engine and all rotating parts against damage by excessive speed.
6. Check the mixer for stability.
7. The full mixer drum is heavy - BE CAREFUL when emptying the drum.
8. The mixer must necessarily be unplugged before:
 - (1) Relocation and transport
 - (2) Cleaning, servicing and repair
 - (3) Failure removal
 - (4) Check the connecting cables if not knotty or damaged
 - (5) Leaving (even in case of short interruption)

STORAGE

Keep any equipment not being used in dry and locked spaces.

TRANSPORT













Move the concrete mixer with trailer.







WORK INSTRUCTIONS

Mixture production:

1. Add water and a couple of additive shovels (sand, gravel, etc.)
2. Add a couple of binder shovels (cement, lime, etc.)
3. Repeat points 1 and 2 until the required mixture ratio is achieved.
4. Let the mixture mix up properly.
5. Ask for advice from a professional for the mixture composition and quality.

5. SYMBOLS

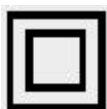
	Caution!
	Always wear goggles when using the machine.
	Wear gloves!
	Wear safety shoes with steel reinforcement!
	Wear ear protectors!
	Always wear a breathing mask
	Always unplug the machine when not in use, before moving, making adjustments, changing parts, cleaning or working the machine.
	Keep distance of persons
	Do not touch inside the running mixer drum!
	(Rotary stirrer). Keep adequate safety distance from the mixer. Prevent any contact with the rotary or moving parts of the machine.
	Never attempt to move the machine when it is loaded and/or
	Do not tow the machine with any vehicle.
	Take any residual materials to an authorized collection point or follow the regulations in the country where the machine is used. Do not discharge into drains, soil or water.

	<p>Only use the machine on a solid, flat and level surface.</p>
	<p>Replace damaged, missing or failing parts before using the machine.</p>
	<p>Before switching on, always remove adjustment tools, shovels, hand trowels, and other tools from the machine area.</p>
	<p>Keep your hands away from all moving parts.</p>
	<p>Warning against dangerous voltage</p>
	<p>Sound power level L_{WA}</p>
	<p>CE marking</p>
	<p>Protection class II</p>
	<p>Any damaged or disposed electric or electronic devices must be delivered to appropriate collection centres.</p>
	<p>Do not operate in raining.</p>

6. PRODUCT DESCRIPTION

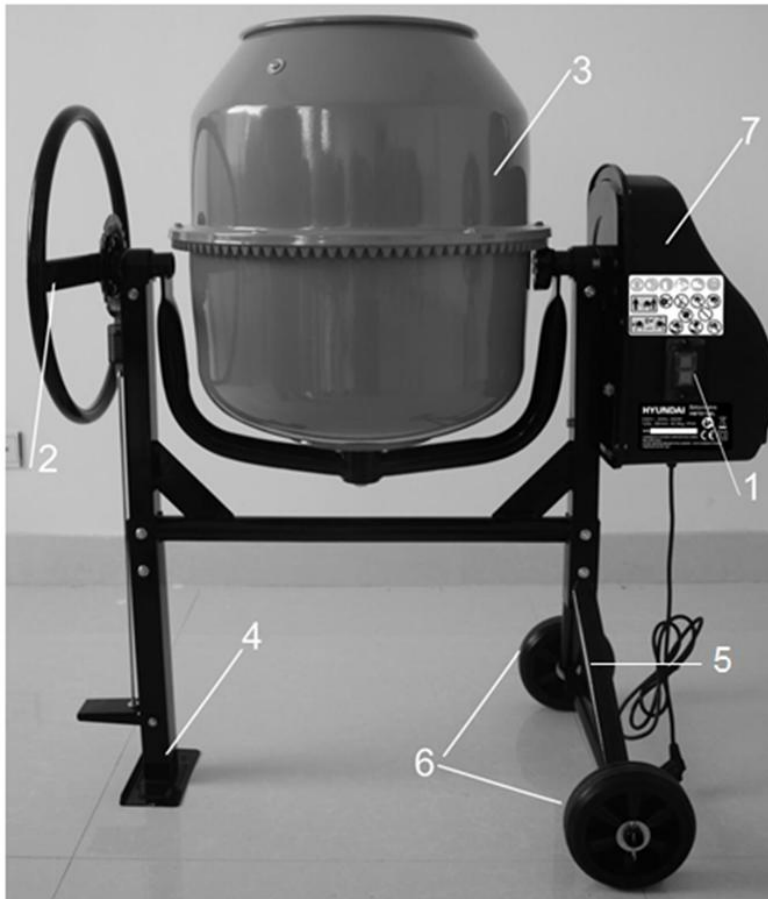

- | | |
|--------------------|----------------------|
| 1. ON/OFF switch | 5. Wheel bracket |
| 2. Operating wheel | 6. Wheels |
| 3. Drum | 7. Motor compartment |
| 4. Support bracket | |

7. TECHNICAL DATA

Model	HBTE125L	HBTE145L	HBTE180L
Mains voltage	230V~, 50Hz	230V~, 50Hz	230V~, 50Hz
Power input	550W	550W	850W
Speed	29/min	29/min	30/min
Drum capacity	125L	145L	180L
Drum mouth size	330mm	390mm	390mm
Weight 39.2kg		43kg	48.8kg
Degree of protection	IP44	IP44	IP44
Overall dimensions LxWxH in mm	1070x665x1230	1160x720x1325	1170x740x1390
Sound pressure level L _{pA}	73.5dB(A)	73.5dB(A)	73.5dB(A)

Guaranteed sound power level L_{WA}	95dB(A)	95dB(A)	95dB(A)
---------------------------------------	---------	---------	---------

8. ASSEMBLY INSTRUCTIONS



Two people assist in assembly recommended.

Step1

Take out the wheels, wheels brackets, the support bracket and the frame as shown.

Step1



Step2

Assemble the support wheels and the wheels

Take the support wheels and the wheels, 4 washers and 2 pins as shown.

Step2



Step3

Place 1 washer in each side of the wheels, insert the pins in the holes of tube and bend the pin bottom to fix the wheels with tool as shown.

Step3



Step4

Assemble the support wheels, the support bracket and the frame. The frame must be assembled with the side with spring seat as shown. Install 4 screws M8*65 and nuts M8 in the 4 places as circled to fix the whole bracket.

Step4

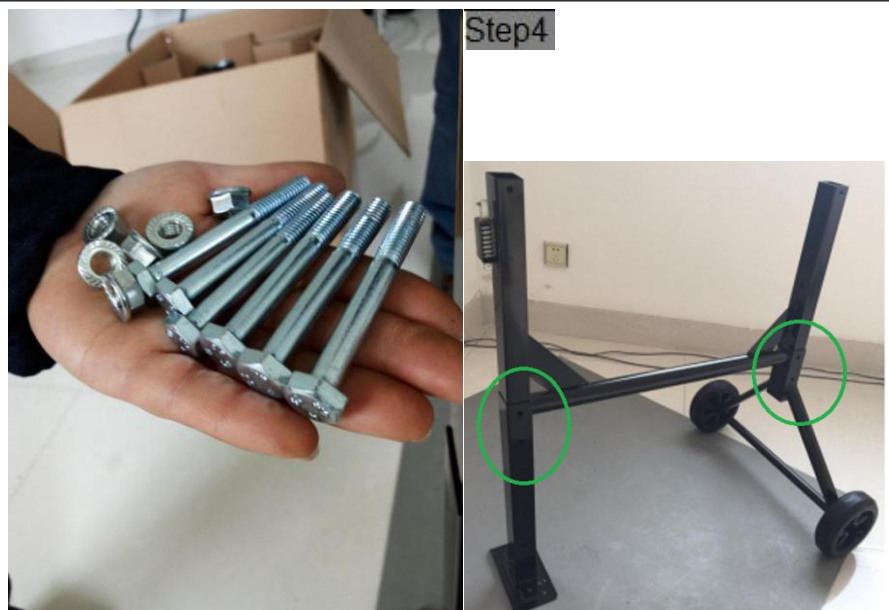

Step5

Install the screw M8*70 and lock nut M8 (with blue rubber ring inside) as shown to fix the pedal.

Step5



Step6:

Assemble the pedal

Step6:



Step7

Take out the lower drum (2 people shall do it) by holding the 2 sides of the curved bracket and put in place as circled.

Step7



Step8:

Install the tie rod, washer M6, spring washer M5 and 2 nuts M5 in order as shown; tighten the 2 nuts M5 to fix the tie rod.

Step8:

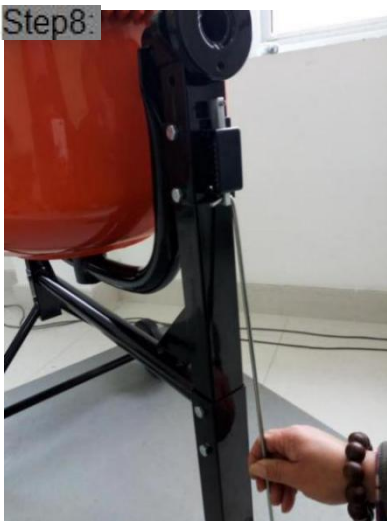

Step9:

Assemble the steering wheel
Use 2 sets of screw M8*16 & spring washer M8 & washer M8 as shown to fix.

Step9:



Step10:

Assemble the mixer blades and lower drum
Install 2 sets of screw M8*16 & washer M8 inside and 2 nut M8 outside as shown to fix the bottom of the mixer blades.

Step10:



Step11:

Assemble the upper drum and large plain washer
Install 6 sets of screw M6*16 & washer M6 in holes as shown.

Step11:



Step12:

Assemble the upper and lower drum according to the arrows, tighten the screws with nuts.

Step12:



Step13:

Install 2 sets of screw M8*16 & washer M8 outside and 2 nuts inside to fix the top of the mixer blades.

Step14:

Tighten the screws and nuts with tools as shown.

Step13:



Step14:



Step15:

Install 2 screws M8*60 and nuts in the the circled holes.

Step15:



Step16:
Assemble the motor.



Step17:
Install 2 sets of screw M8*25 & spring washer M8 & washer M8 in the 2 circled holes to fix the motor.

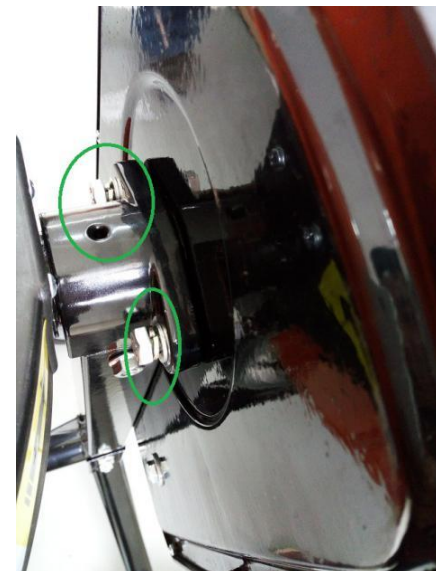

Step18:
Rotate the drum as shown, install screw M8*55 & spring washer M8 & washer M8 to fix the motor.



Step19:

Make sure that the product is well installed.

Step19:



9. OPERATION INSTRUCTIONS

9.1 DRUM TILTING

The spring-loaded tipping wheel with locking lugs provides an easy positive control of the drum which can be locked in the mix, discharge and stored position.

The drum is locked in position by lugs on the self-locating tipping wheel which engage into the locking plate on the mixer frame. To tilt the drum, withdrawn the tipping wheel to dis-engage the locking lugs. This then allows the tipping wheel and drum to be turned in the same direction.

To retain the drum in position, aligning the lugs with the slots, release the tipping wheel a little while retaining the drum. Rotate the tipping wheel until the locking lugs engage into the locking plate on the mixer frame.

9.2 LOADING/ MIXING POSITION

For Mortar

For Concrete

Emptying Position

Storage Position

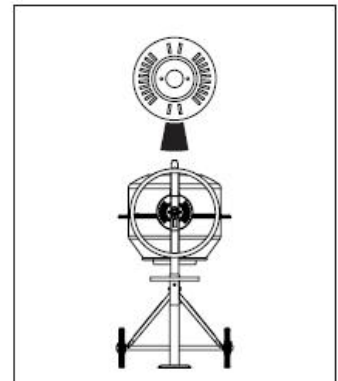
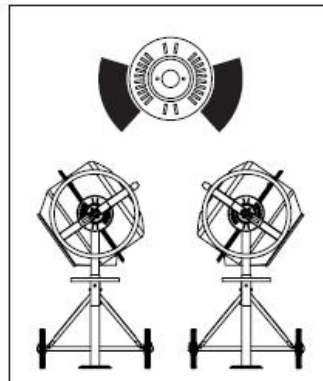
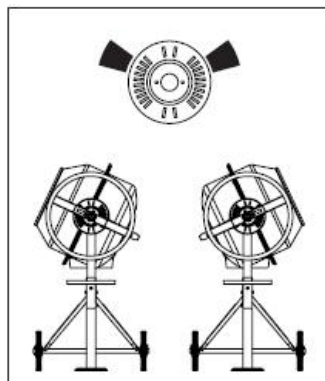
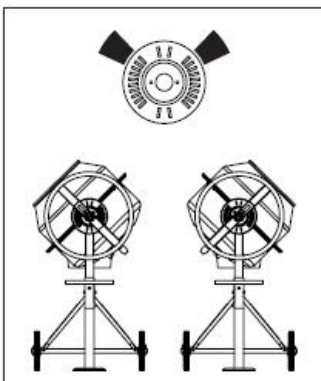

9.3 LOADING



Completely unwind the extension cord. Connect it to the concrete mixer first before plugging in power supply.



Always start the mixer before loading the drum. Loading the drum with drum rotating.



Do not throw material into the mixer to avoid sticking firmly to the back of the drum. Trickle it steadily over the ram.

NOTE: A built-in thermal protector is arranged in the motor to prevent it from overheating. The thermal protector restores automatically when the motor cools down.

For best results, proceed as follows:

1. Add the required amount of gravel into the drum.
2. Add the required amount of cement into the drum.
3. Add the required amount of sand into the drum.
4. Pour the required amount of water into the drum.

9.4 EMPTYING



Do not turn mixer off while full of load. Emptying the drum with drum rotating.

9.5 CLEANING



Never put hands inside the drum with drum rotating.

Thoroughly clean the mixer at the end of each day's operation. Keep your mixer clean. The slightest trace of material left in the drum will harden and attract more each time you use it until the machine is useless. Dried cement should be scraped out of the drum. Do not throw bricks into mixer drum to clean it out. Do not beat on the drum with a shovel, a hammer or other tools to break up accumulations of dried cement mix, as damage to the mixer may result. The drum may be scoured for approximate 2 minutes, using 1" gravel and water mixture. Then discharge the gravel/water mixture and hose down the drum assembly inside and out. The construction of protection class IP44 of the concrete mixer allows you to safely water the drum.



Do not pour or spray water directly over the motor cover, especially the openings in it.



Wipe off any external material on the motor cover. Do not use petrol, turpentine, lacquer or paint thinner, dry cleaning fluids or similar products. The use of chemical products or solvents may affect the properties of the cover which was made of high density polyethylene PET.

10. MAINTENANCE INSTRUCTIONS

 **Ensure the extension cord is always unplugged before the motor cover is removed.**

The drive belt is under constant even tension by a spring loaded jockey. No adjustment apart from a touch of grease on the spindle.

The bearings are sealed for life.

 **The wiring diagram and parts schematic in this manual are as reference tools only. Neither the manufacturer nor distributor makes any representation or warranty of any kind to the buyer that he or she is qualified to make any repairs to the product or that he or she is qualified to replace any parts of the product. Only qualified technicians should repair the mixer. Any maintenance and repairs carried out, to any of the electric components must be undertaken by a qualified electrician.**

Parts in a circle should only be fitted by a qualified electrician.

WIRING DIAGRAM

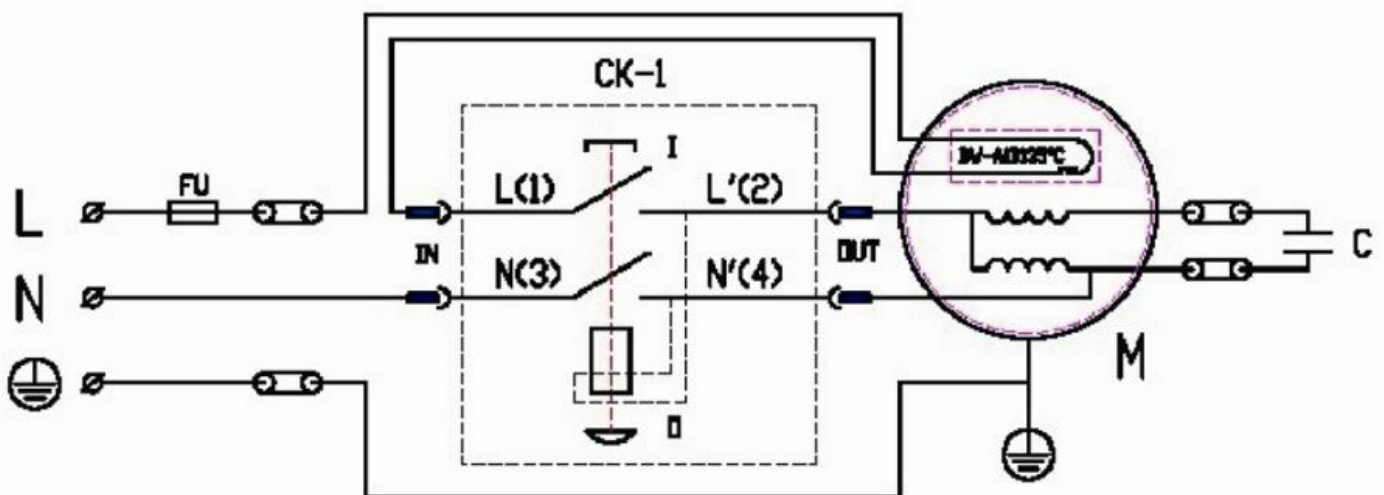

11. DISPOSAL



Electrical products should not be discarded with household products. According to the European Directive 2012/19/EU on waste electrical and electronic equipment and its implementation into national law, electrical products used must be collected separately and disposed of at collection points provided for this purpose. Talk with your local authorities or dealer for advice on recycling.

12. DECLARATION OF CONFORMITY



BUIDER SAS

ZI, 32 rue Aristide Bergès – 31270 Cugnaux – France

Declare that the following machine:

CONCRETE MIXER

HBTE125L/HBTE145L/HBTE180L

Serial number: 20230305350-20230305464 (HBTE125L)

20230305478-20230305624 (HBTE145L)

20230305625-20230305679 (HBTE180L)

**Is in conformity with the Directive Machine 2006/42/EC and with the regulation
transposing it**

Also in conformity with the following Directives:

EMC Directive 2014/30/UE

RoHS Directive 2011/65/UE & (EU) 2015/863

Also in conformity with the following standards

EN 12151:2007

EN 60204-1:2018

EN ISO12100:2010

EN 55014-1:2017/+A11:2020

EN55014-2:2015

EN IEC61000-3-2:2019

EN 61000-3-3:2013/A1:2019

Guaranteed sound power level LWA : 95dB (A)

The guaranteed sound power level has been measured according to the requirements of EN 12151:2007

Responsible of the technical file: Mr Patriarca

Cugnaux, 15/02/2023

Philippe MARIE / PDG

13. WARRANTY

HYUNDAI

WARRANTY

The manufacturer guarantees the product against defects in material and workmanship for a period of 2 years from the date of the original purchase. The warranty only applies if the product is for household use. The warranty does not cover breakdowns due to normal wear and tear.

The manufacturer agrees to replace parts identified as defective by the designated distributor. The manufacturer does not accept responsibility for the replacement of the machine, in whole or in part, and/or ensuing damage.

The warranty does not cover breakdowns due to:

- insufficient maintenance.
- abnormal assembly, adjustment or operations of the product.
- parts subject to normal wear and tear.

The warranty does not extend to:

- shipping and packaging costs.
- using the tool for a purpose other than that for which it was designed.
- the use and maintenance of the machine done in a manner not described in the user manual.

Due to our policy of continuous product improvement, we reserve the right to alter or change specifications without notice. Consequently, the product may be different from the information contained therein, but a modification will be undertaken without notice if it is recognized as an improvement of the preceding characteristic.

READ THE MANUAL CAREFULLY BEFORE USING THE MACHINE.

When ordering spare parts, please indicate the part number or code, you can find this in the spare parts list in this manual. Keep the purchase receipt; without it, the warranty is invalid. To help you with your product, we invite you to contact us by phone or via our website:

- **+33 (0)9.70.75.30.30**
- **<https://services.swap-europe.com/contact>**

You must create a "ticket" via the web platform.

- Register or create your account.
- Indicate the reference of the tool.
- Choose the subject of your request.
- Describe your problem.
- Attach these files: invoice or sales receipt, photo of the identification plate (serial number), photo of the part you need (for example: pins on the transformer plug which are broken).



14. PRODUCT FAILURE

WHAT TO DO IF MY MACHINE BREAKS DOWN?

If you bought your product in a store:

- a) Empty the fuel tank if your product has one.
- b) Make sure that your machine is complete with all accessories supplied, and clean! If this is not the case, the repairer will refuse the machine.

Go to the store with the complete machine and with the receipt or invoice.

If you bought your product on a website:

- a) Empty the fuel tank if your product has one..
- b) Make sure that your machine is complete with all accessories supplied, and clean! If this is not the case, the repairer will refuse the machine.
- c) Create a SWAP-Europe service ticket on the site: <https://services.swap-europe.com> When making the request on SWAP-Europe, you must attach the invoice and the photo of the nameplate (serial number).
- d) Contact the repair station to make sure it is available before dropping off the machine.

Go to the repair station with the complete machine packed, accompanied by the purchase invoice and the station support sheet downloadable after the service request is completed on the SWAP-Europe site

For machines with engine failure from manufacturers BRIGGS & STRATTON, HONDA and RATO, please refer to the following instructions.

Repairs will be done by approved engine manufacturers of these manufacturers, see their site:

- <http://www.briggsandstratton.com/eu/fr>
- <http://www.honda-engines-eu.com/fr/service-network-page;jsessionid=5EE8456CF39CD572AA2AEEDFD290CDAE>
- <https://www.rato-europe.com/it/service-network>

Please keep your original packaging to allow for after-sales service returns or pack your machine with a similar cardboard box of the same dimensions.

For any question concerning our after-sales service you can make a request on our website <https://services.swap-europe.com>

Our hotline remains available at +33 (9) 70 75 30 30.



15. WARRANTY EXCLUSIONS

THE WARRANTY DOES NOT COVER:

- Start-up and setting up of the product.
- Damage resulting from normal wear and tear of the product.
- Damage resulting from improper use of the product.
- Damage resulting from assembly or start-up not in accordance with the user manual.
- Breakdowns related to carburetion beyond 90 days and fouling of carburetors.
- Periodic and standard maintenance events.
- Actions of modification and dismantling that directly void the warranty.
- Products whose original authentication marking (brand, serial number) has been degraded, altered or withdrawn.
- Replacement of consumables.
- The use of non-original parts.
- Breakage of parts following impacts or projections.
- Accessories breakdowns.
- Defects and their consequences linked to any external cause.
- Loss of components and loss due to insufficient screwing.
- Cutting components and any damage related to the loosening of parts.
- Overload or overheating.
- Poor power supply quality: faulty voltage, voltage error, etc.
- Damages resulting from the deprivation of enjoyment of the product during the time necessary for repairs and more generally the costs related to the immobilization of the product.
- The costs of a second opinion established by a third party following an estimate by a SWAP-Europe repair station
- The use of a product which would show a defect or a breakage which was not the subject of an immediate report and/or repair with the services of SWAP-Europe.
- Deterioration linked to transport and storage*.
- Launchers beyond 90 days.
- Oil, petrol, grease.
- Damages related to the use of non-compliant fuels or lubricants.

* In accordance with transport legislation, damage related to transport must be declared to carriers within 48 hours maximum after observation by registered letter with acknowledgement of receipt.

This document is a supplement to your notice, a non-exhaustive list.

Attention: all orders must be checked in the presence of the delivery person. In case of refusal by the delivery person, it you must simply refuse the delivery and notify your refusal.

Reminder: the reserves do not exclude the notification by registered letter with acknowledgement within 72 hours.

Information: Thermal devices must be wintered each season (service available on the SWAP-Europe site). Batteries must be charged before being stored.

HYUNDAI
POWER PRODUCTS

For inquiries, please contact:

BUILDER SAS

32 rue Aristide Bergès - Z.I. du Casque - 31270 Cugnaux - France

Tél.: +33(0)5.34.502.502 Fax.: +33(0)5.34.502.503

<http://www.hyundaipower-fr.com/>

Fabriqué en République Populaire de Chine(PRC)